

Project Name:	Part Number:	Type:
---------------	--------------	-------

LANCE 2' X 4'

LED - LATCH AND CLOSE



407-478-3759
www.ilp-inc.com

FEATURES

- LED Retrofit Kit for recessed lighting application
- One-piece unit with universal mounting brackets for rapid installation
- 3000K, 3500K, 4000K, and 5000K CCT
- Pre-painted aluminum
- Acrylic frosted lens easily removes for cleaning
- Toolless access to driver
- 0-10V Dimmable Driver (100% - 10%)
- ETL Listed for (UL1598C)
- 5 year warranty on components
- DesignLights Consortium® Qualified Luminaire



SUITABLE APPLICATIONS

- 2x4's
- Parabolic Louvers
- Prismatic Lenses
- Air-Handling Units (Custom Configuration, Contact Factory)

LED SYSTEMS INFO	22W	30W	35W	42W	47W	55W
Calculated L ₇₀ (TM-21)	>100K	>100K	>100K	>100K	>100K	>100K
Delivered Lumens	2,948 lm	3,923 lm	4,400 lm	5,254 lm	6,156 lm	7,053 lm
Total Input Watts	22 W	30 W	34 W	42 W	47 W	55 W
Luminaire Efficacy Rating (LER)	134 lm/W	129 lm/W	131 lm/W	124 lm/W	131 lm/W	128 lm/W
Correlated Color Temperature (CCT)	4000K	4000K	4000K	4000K	4000K	4000K
Color Rendering Index (CRI)	>80	>80	>80	>80	>80	>80
Ambient Temperature Range	110°F	110°F	110°F	110°F	110°F	110°F
Universal Driver	120-277 V	120-277 V	120-277 V	120-277 V	120-277 V	120-277 V

LED System data above based on LANCE24-22WLED-UNIV40, LANCE24-30WLED-UNIV40, LANCE24-35WLED-UNIV40, LANCE24-42WLED-UNIV40, LANCE24-47WLED-UNIV40 & LANCE24-55WLED-UNIV40. LED Lumen maintenance estimates based on TM-21 projections for the light source at 25°C ambient.

ORDERING GUIDE:

Series	Watts	Driver	Color	Options
LANCE24 Latch & Close 2'x4'	22WLED	UNIV 120-277V Driver	50	POSTP Post Painted Aluminum
	30WLED		40	ES EasySense Control
	35WLED		35	ES/PCD Pre-Installed App on Control Device for Commissioning
	42WLED		30	ES/WWS EasySense Wall Switch
	47WLED			SR Sensor Ready Driver
	55WLED			DR DALI-Ready Driver
				VDO[‡] Lutron Vive DFCSJ-OEM-OCC (Daylight & Occupancy)
		VRF[‡] Lutron Vive DFCSJ-OEM-RF (RF Only)		
		DIM DIM leads to Driver		
		DIMxx Factory Set Custom Dim Level (1% Dimming Driver)		
		BLD Bi-Level Dim Driver (2 hot leads)		
		F1/ILBCP05[‡] Factory Installed 5W LED Battery Backup		
		F1/ILBCP07[‡] Factory Installed 7W LED Battery Backup		
		F1/ILBCP10[‡] Factory Installed 10W LED Battery Backup		
		F1/ILBCP12[‡] Factory Installed 12W LED Battery Backup		
		SD480 480V Step Down Transformer		
		SD347 347V Step Down Transformer		

DLC Premium includes:

LANCE24-22WLED-UNIV-30, LANCE24-22WLED-UNIV-35, LANCE24-22WLED-UNIV-40, LANCE24-22WLED-UNIV-50, LANCE24-30WLED-UNIV-35, LANCE24-30WLED-UNIV-40, LANCE24-30WLED-UNIV-50, LANCE24-35WLED-UNIV-40, LANCE24-35WLED-UNIV-50, LANCE24-42WLED-UNIV-50, LANCE24-47WLED-UNIV-30, LANCE24-47WLED-UNIV-35, LANCE24-47WLED-UNIV-40, LANCE24-47WLED-UNIV-50, LANCE24-55WLED-UNIV-30, LANCE24-55WLED-UNIV-35, LANCE24-55WLED-UNIV-40, LANCE24-55WLED-UNIV-50

[‡]BB performance data available on field installed LED BB Sheet
[‡]Must be used with SR Driver

LANCE 2'X4'

LED - LATCH AND CLOSE

LINE DRAWINGS

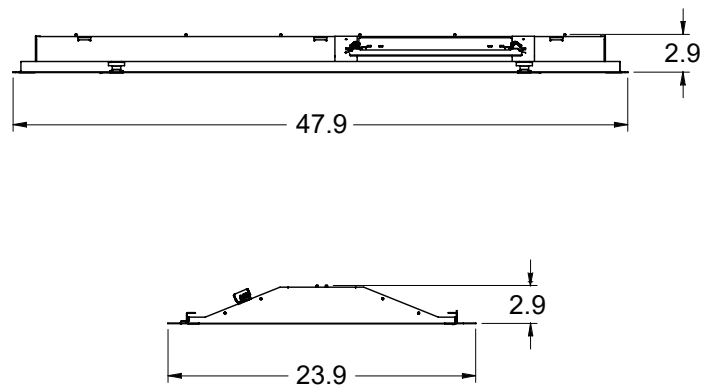
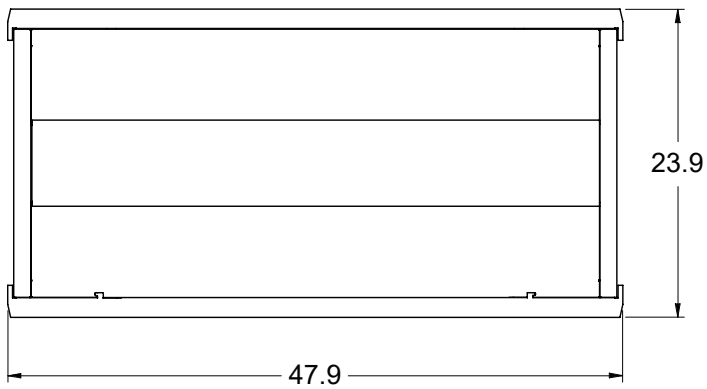

MOUNTING OPTIONS



Universal Mounting Bracket

LANCE 2' X 4'

LED - LATCH AND CLOSE

INSTALLATION INSTRUCTIONS

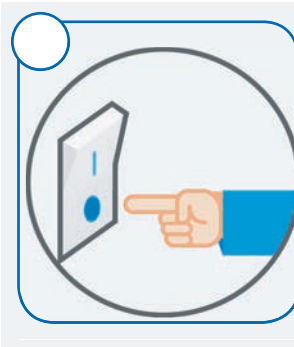

STEP 1

Shut off or disconnect power to the fixture.

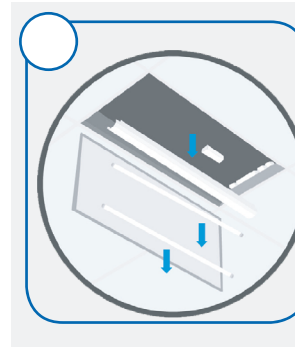

STEP 2

Remove existing fluorescent lamps and components, then disconnect existing connections to the fluorescent ballast.

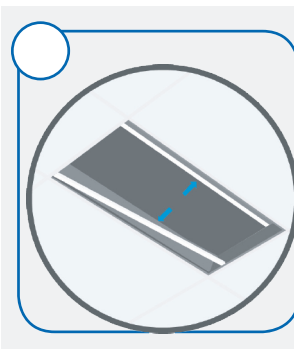

STEP 3

Gently lift the original housing and insert the brackets between the housing and the T-grid. Allow the housing to rest on the brackets, securing them in place.

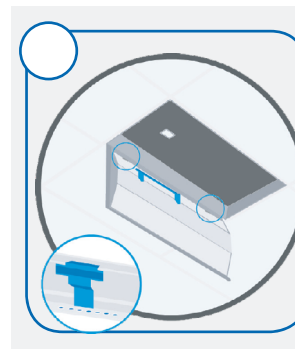

STEP 4

Hang the LANCE body by hooking the T-hinges into the respective slots in the bracket.

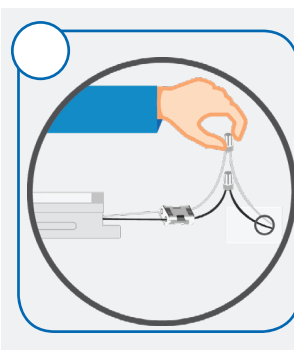

STEP 5

Connect the LANCE to AC power and ground.

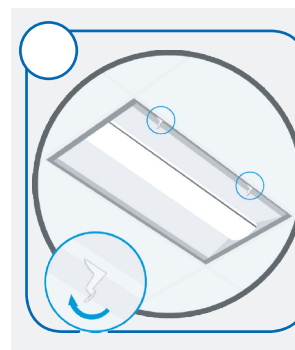

STEP 6

Rotate the LANCE body up into the fixture and close the latches. Turn on or reconnect power to the fixture to complete the installation.

ILP Recommends a Test Install be Performed Prior to Placing Order.