

SQ

CURVED WRAP

FEATURES

- 2ft, 4ft and 8ft configurations
- Sleek curved profile frosted acrylic impact resistant lens
- .040" aluminum pre-painted white housing
- Ceiling, wall or suspension mounting options
- Suitable for installing in continuous runs
- ASLFMB Adjustable Sliding Fixture Mounting Box option will provide a pendant-ready solution perfect for retrofits when pendant locations are unknown or inconsistent
- 3000K - 5000K CCT
- 0-10V Dimmable Driver (100% - 10%)
- 120-277V Universal Voltage
- Calculated L70>100,000 hrs @ 25°C per TM-21-11
- 5 Year Warranty (std); 10 Year Warranty Optional
- DesignLights Consortium Qualified Luminaire
- ETL Listed for Damp Location
- Build America Buy America (BABA) Compliant



407-478-3759
www.ilp-inc.com



SUITABLE APPLICATIONS

- Office
- Hospitals
- Education
- Hallways
- Work Station Task Lighting
- Multipurpose

ORDERING GUIDE:

SERIES	LUMENS	DRIVER	CCT	WARRANTY	COMPLIANCE	
SQ2	2ft Curved Wrap	U 120-277V	2L	BLANK 5 Year 10YR ¹ 10 Year	BABA Build America Buy America Compliant	
			3L			
			40			
SQ4	4ft Curved Wrap	U 120-277V	4L	BLANK 5 Year 10YR ¹ 10 Year	BABA Build America Buy America Compliant	
			6L			35
						30
SQ8	8ft Curved Wrap	U 120-277V	4L	BLANK 5 Year 10YR ¹ 10 Year	BABA Build America Buy America Compliant	
			8L			
			12L			

OPTIONS	
Factory Installed	
Cx/yW	Cord (x=Length;6,10,15) (y=# of conductors; 3,4,5,6)
RW/3W ²	3 Wire Raceway Wiring Harness for continuous wiring through fixture (non-dimming)
RW/5W ²	5 Wire Raceway Wiring Harness for continuous wiring through fixture (dimming)
ASLFMB ⁶	Adjustable Sliding Fixture Mounting Box system (with alignment bracket)
Ship With Accessories	
WC ⁷	11 GA Wire Cage
FMB ^{3,4}	Fixture Mounting Box
HUB 3/4 ^{3,5}	Conduit Hub 3/4" for pendant mount
ACxY ⁸	Y-Toggle Cable System (X=in)
ALBR ²	Alignment Bracket (used to align fixtures mounted in continuous rows)

¹Contact factory for more details

²Used only when mounting in continuous rows

³One needed per 4 ft section

⁴Must use with HUB3/4

⁵Must use with FMB

⁶Not available with 2 ft models

⁷Does not qualify for DLC

⁸Not BABA compliant

CURVED WRAP

LED SYSTEMS INFO ¹	3000K CCT		3500K CCT		4000K CCT		5000K CCT		Watts ²	CRI	Ambient Temperature Range
	Part #	Lumens	Efficacy	Lumens	Efficacy	Lumens	Efficacy	Lumens			
SQ2-2L-U-XX	2,043 lm	126 lm/W	2,063 lm	128 lm/W	2,084 lm	129 lm/W	2,125 lm	131 lm/W	16 W	>80	-4°F to 122°F
SQ2-3L-U-XX	2,651 lm	119 lm/W	2,677 lm	120 lm/W	2,704 lm	121 lm/W	2,757 lm	124 lm/W	22 W	>80	-4°F to 122°F
SQ4-2L-U-XX	2,202 lm	144 lm/W	2,247 lm	146 lm/W	2,278 lm	148 lm/W	2,340 lm	152 lm/W	15 W	>80	-4°F to 113°F
SQ4-4L-U-XX	4,060 lm	138 lm/W	4,117 lm	142 lm/W	4,174 lm	144 lm/W	4,288 lm	148 lm/W	29 W	>80	-4°F to 113°F
SQ4-6L-U-XX	5,501 lm	128 lm/W	5,582 lm	130 lm/W	5,659 lm	131 lm/W	5,866 lm	135 lm/W	43 W	>80	-4°F to 113°F
SQ8-4L-U-XX	4,574 lm	144 lm/W	4,620 lm	145 lm/W	4,665 lm	146 lm/W	4,757 lm	149 lm/W	32 W	>80	-4°F to 113°F
SQ8-8L-U-XX	7,715 lm	133 lm/W	7,792 lm	134 lm/W	7,869 lm	135 lm/W	8,023 lm	138 lm/W	58 W	>80	-4°F to 113°F
SQ8-12L-U-XX	10,500 lm	121 lm/W	10,605 lm	123 lm/W	10,710 lm	124 lm/W	10,920 lm	126 lm/W	87 W	>80	-4°F to 113°F

¹LED Chips are frequently updated therefore values are nominal

²Electrical data at 25C (77F). Actual wattage may differ by +/-10%.

OPTIONS



CORDx

Cords available in 6ft, 10ft, 12ft & 20ft (Inquire for additional options) Plug options available

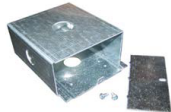

FMB

Includes rigid box to attach to the fixture, provides for dual point mounting to accept a pendant, hook or conduit hub (sold separately)



HUB 3/4

Conduit Hub
3/4" for Pendant
Mounting



HB-XX-18Y-PAD

Includes 2 adjustable cable hangers. Available in 60", 120", 180" & 240"



ASLFMB

Adjustable Sliding Fixture
Mounting Box system
(with alignment bracket)

SQ

CURVED WRAP

LINE DRAWINGS

2ft Dimensions

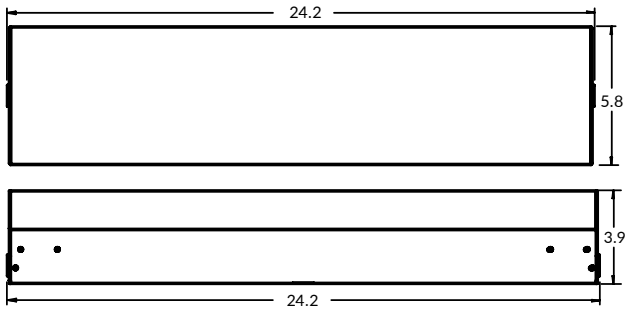
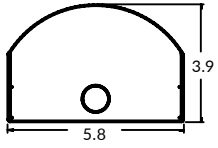

4ft Dimensions

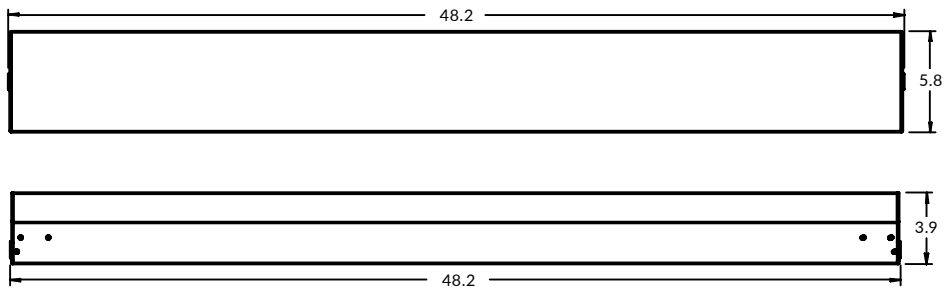
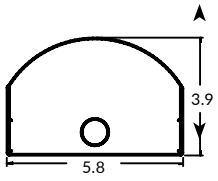

8ft Dimensions

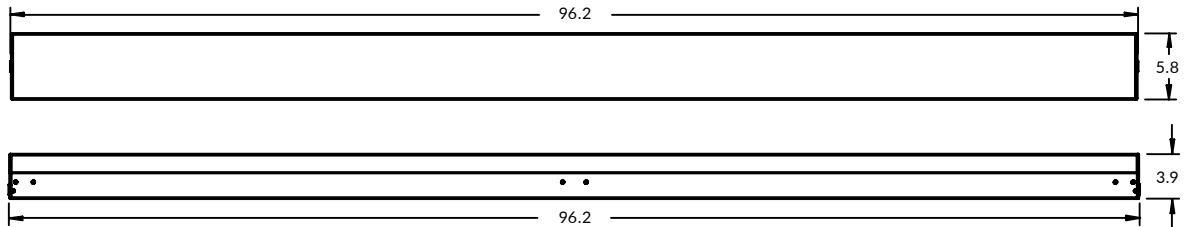
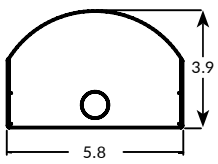

SQ

CURVED WRAP

LINE DRAWINGS

ASLFMB OPION DETAILS

4ft Model

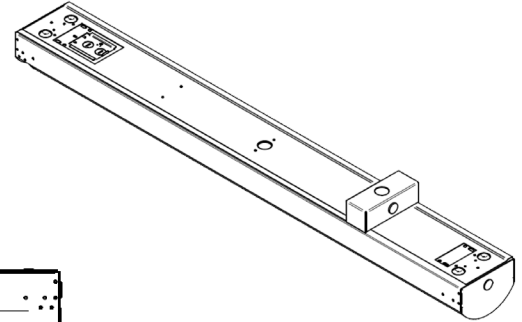
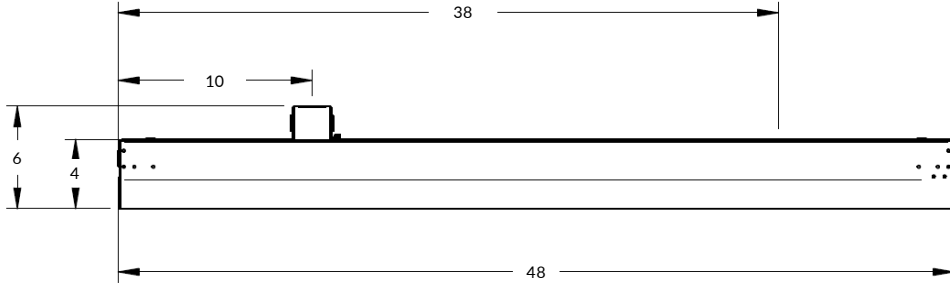

*Dimensions shown above are applicable when the fixtures are the middle units of a continuously mounted set of fixtures.
Please see intallation instructions for limitations on end mounted fixtures.

8ft Model

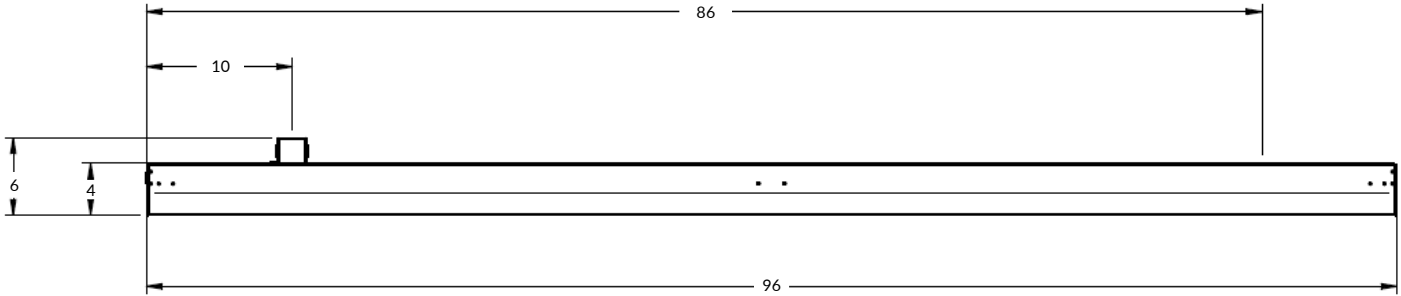

*Dimensions shown above are applicable when the fixtures are the middle units of a continuously mounted set of fixtures.
Please see intallation instructions for limitations on end mounted fixtures.

CURVED WRAP

PHOTOMETRIC DATA

LUMINAIRE DATA	
Part Number	SQ4-4L-U-40
Description	4ft Curved Wrap, 4,000 Lumens, 4000K, Frosted Lens
Fixture Lumens (lm)	4178 lm
Wattage (W)	29W
Efficacy (lm/W)	144 lm/W
Mounting	Pendant
Spacing Criteria	0° = 1.19, 90° = 1.32

ZONAL LUMEN SUMMARY		
Zone	Lumens (lm)	% Fixture
0° - 40°	1587	38%
0° - 60°	2829	68%
0° - 90°	3956	95%
90° - 180°	222	5%
0° - 180°	4178	100%

